

**New**

# Universal Clamp

---



Model LKK

Link Clamp for Workholding

# Universal Clamp

Model LKK Hydraulic Double Action



Link Clamp  
with the Clamp Lever Rotatable at 360 Degrees

PAT.

## Features

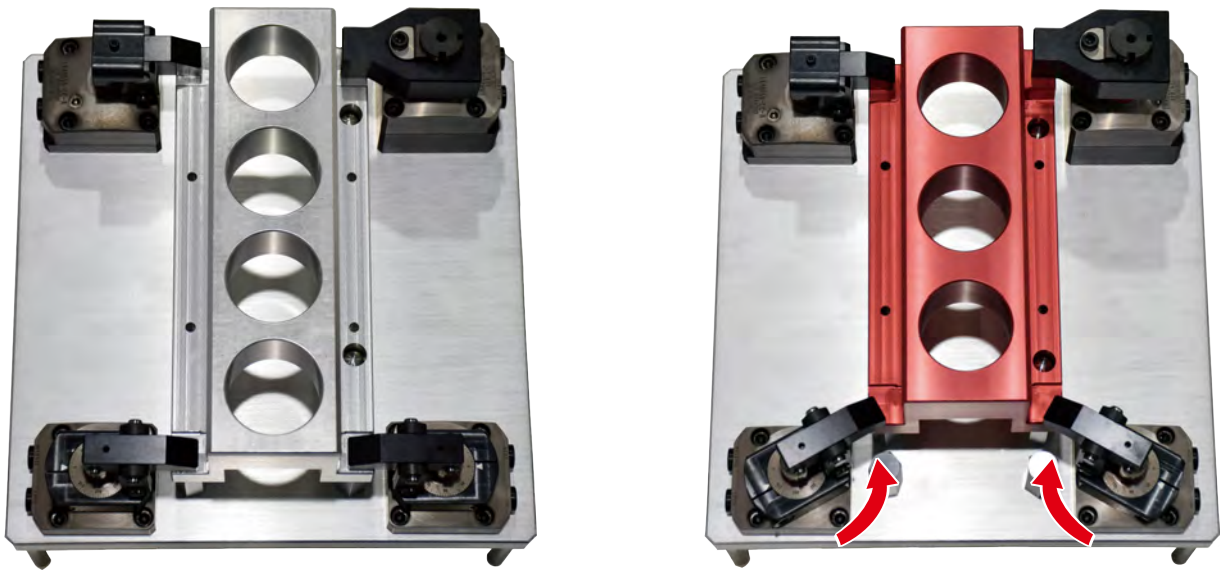

**360° Rotatable Lever Enables to Clamp Various Workpieces**

Ex.) Turn the Lever by 30° to clamp two different workpieces.

## Action Description

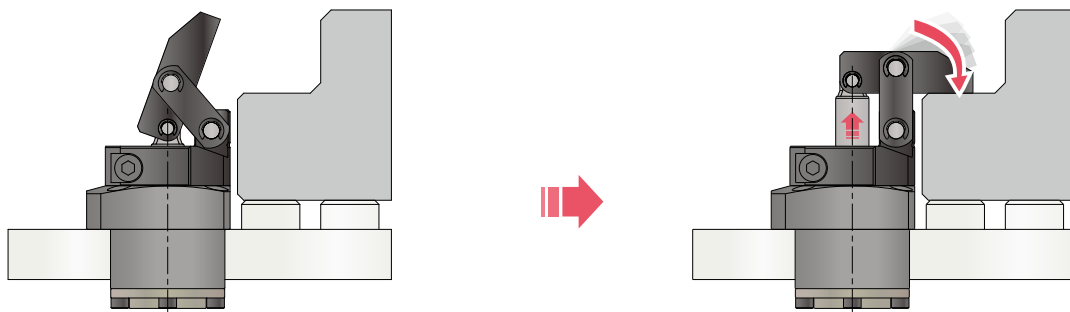

Released State

Locked State

## • Cross Section

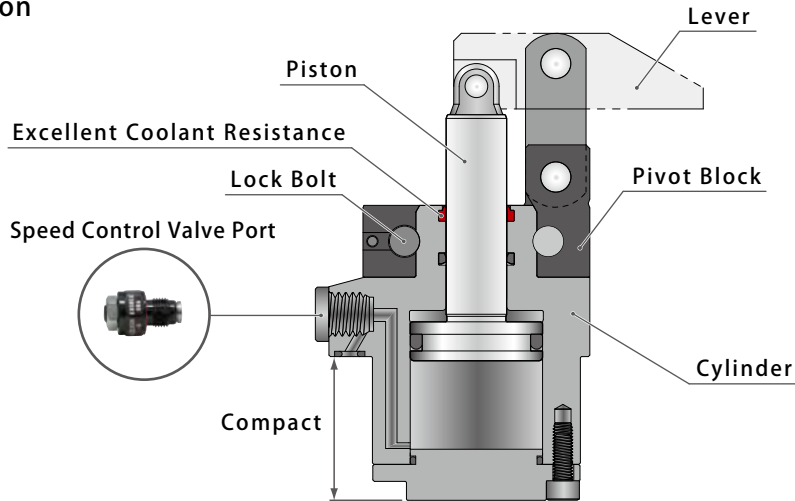

## • Just One Wrench Required to Position the 360° Rotatable Lever in Any Direction!

### Lever Direction Changing Procedure

- ① Loosen the Lock Bolt at released state. ② Turn the Pivot Block. (Angle Scale in 5° increments.) ③ Tighten the Lock Bolt.

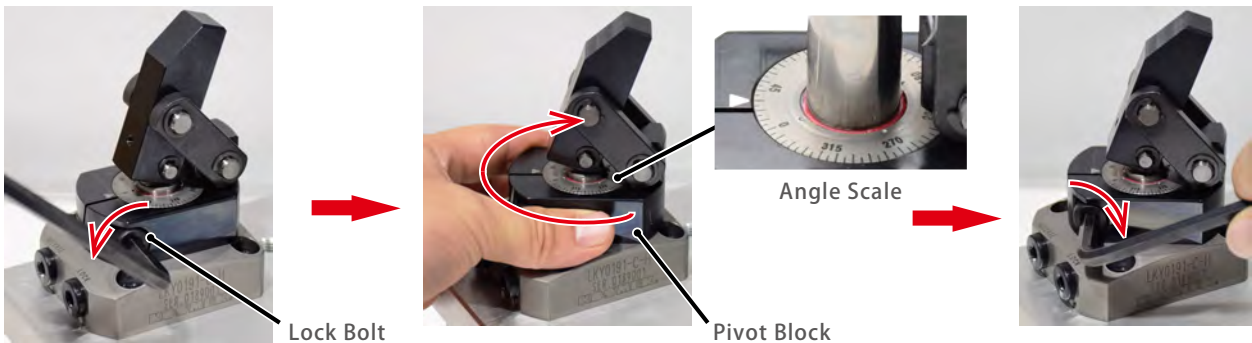

## • No Need of Offset Lever

Able to clamp in any direction within the diameter range of the link lever length. Thus no offset lever is required, allowing for reducing the lever production cost. The Universal Clamp enables to clamp various workpieces just by adjusting its lever direction.

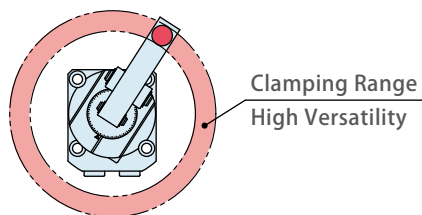

【Universal Clamp】

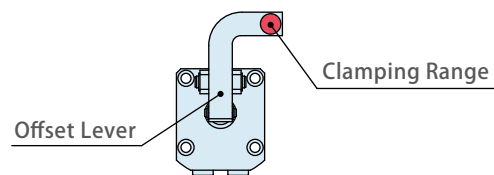

【Current Link Clamp】

## • Simpler Internal Fitting Design Possible!

Since the lever direction is 360° rotatable, internal fitting design can be so simple and there is no need to consider cylinder directions.

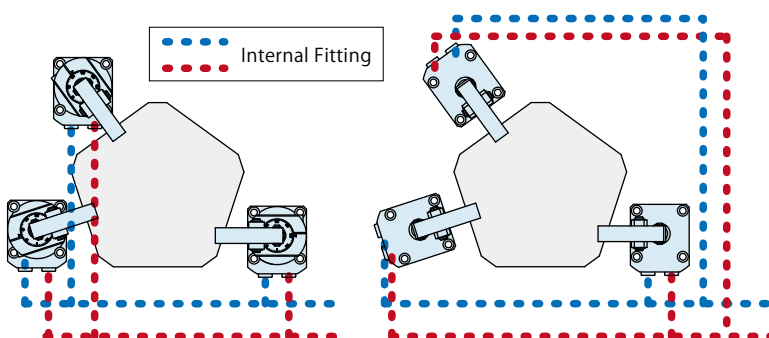

【Universal Clamp】

【General Link Clamp】

## • Quick Lever Change Possible!

Simpler and quicker lever changing is possible by using Quick Change Lever (option A).

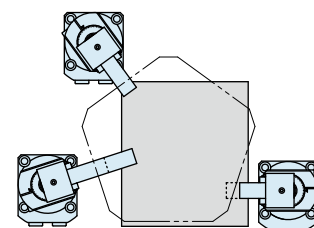

## Model No. Indication

LKK **048** **0** - **C** - **A**

1  
 2  
 3  
 4

### 1 Body Size

**036** :  $\phi D=36\text{mm}$                       **055** :  $\phi D=55\text{mm}$   
**040** :  $\phi D=40\text{mm}$                       **065** :  $\phi D=65\text{mm}$   
**048** :  $\phi D=48\text{mm}$                       **075** :  $\phi D=75\text{mm}$

※ Outer diameter ( $\phi D$ ) of the cylinder.

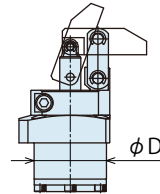

### 2 Design No.

**0** : Revision Number

### 3 Piping Method

**C** : Gasket Option (With G Thread Plug)  
**S** : Piping Option (Rc Thread)

※ Speed control valve (BZL) is sold separately.  
 Please refer to P.15.

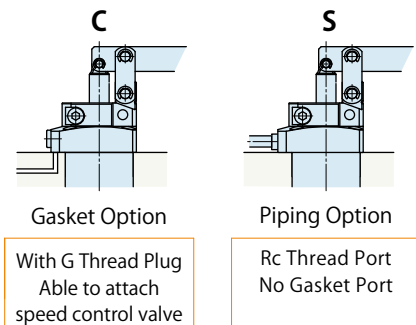

### 4 Option

**Blank** : None (Standard)

**A** : Quick Change Lever Type A

※ Tightening Kit for Quick Change Lever Type A is not included.  
 Refer to P.12 and order the required kit.

※ Quick Change Lever Type A is suitable for frequent lever change.  
 Type A needs no snap rings or special tools, but only a wrench and bolt to change levers, while a standard lever needs a special tool when mounting and removing snap rings that fix a lever pin and rod pin. It takes a lot of time to mount and remove snap rings. Also snap rings may be lost or deformed when changing levers. It is recommended to select option A when changing lever frequently.

**K** : Flange Pin with C Type Circlip

※ Please contact us for a combination of options.

## Specifications

Model No.		LKK0360-□-□	LKK0400-□-□	LKK0480-□-□
Cylinder Area for Locking	cm <sup>2</sup>	4.52	5.31	7.07
Clamping Force (Calculation Formula) <sup>※1</sup>	kN	$F = \frac{5.90 \times P}{L - 14.5}$	$F = \frac{7.64 \times P}{L - 16}$	$F = \frac{11.76 \times P}{L - 18.5}$
Cylinder Capacity cm <sup>3</sup>	when locked	8.4	10.9	16.6
	when released	6.9	8.6	13.0
Cylinder Inner Diameter <sup>※2</sup>	mm	24	26	30
Rod Diameter <sup>※2</sup>	mm	10	12	14
Full Stroke	mm	18.5	20.5	23.5
Lock Stroke	mm	16	17.5	20.5
Extra Stroke	mm	2.5	3	3
Max. Operating Pressure	MPa	7.0		
Min. Operating Pressure <sup>※3</sup>	MPa	0.5		
Withstanding Pressure	MPa	10.5		
Operating Temperature	°C	0 ~ 70		
Usable Fluid		General Hydraulic Oil Equivalent to ISO-VG-32		
Mass <sup>※4</sup>	kg	0.6	0.8	1.3

Model No.		LKK0550-□-□	LKK0650-□-□	LKK0750-□-□
Cylinder Area for Locking	cm <sup>2</sup>	9.62	15.9	23.8
Clamping Force (Calculation Formula) <sup>※1</sup>	kN	$F = \frac{18.18 \times P}{L - 21}$	$F = \frac{35.06 \times P}{L - 24.5}$	$F = \frac{64.14 \times P}{L - 30}$
Cylinder Capacity cm <sup>3</sup>	when locked	25.0	46.9	83.2
	when released	19.8	37.7	69.8
Cylinder Inner Diameter <sup>※2</sup>	mm	35	45	55
Rod Diameter <sup>※2</sup>	mm	16	20	22
Full Stroke	mm	26	29.5	35
Lock Stroke	mm	23	26.5	32
Extra Stroke	mm	3	3	3
Max. Operating Pressure	MPa	7.0		
Min. Operating Pressure <sup>※3</sup>	MPa	0.5		
Withstanding Pressure	MPa	10.5		
Operating Temperature	°C	0 ~ 70		
Usable Fluid		General Hydraulic Oil Equivalent to ISO-VG-32		
Mass <sup>※4</sup>	kg	1.5	2.5	4.0

Notes: ※ 1. F : Clamping Force (kN), P : Supply Air Pressure (MPa), L : Distance between the piston center and the clamping point (mm).

※ 2. Clamping force cannot be calculated from the cylinder inner diameter and rod diameter. Please refer to the clamping force curve.

※ 3. Minimum pressure to operate the clamp without load.

※ 4. Mass of single link clamp without the link lever.

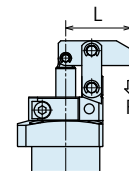

Clamping Force Curve

Model No. Indication

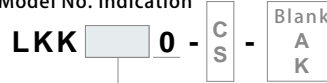

1 Body Size

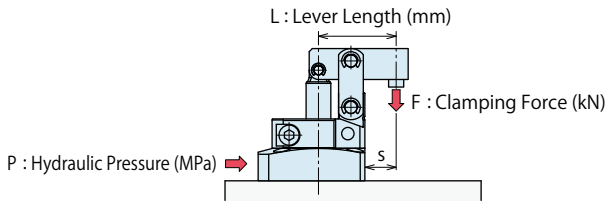

(Ex.) In case of LKK0480,  
Supply Hydraulic Pressure 5.0MPa, Lever Length L=42mm,  
Clamping Force is about 2.6kN.

**LKK0360** - □ - □ Clamping Force Formula <sup>※1</sup> (kN)  $F = (5.90 \times P) / (L - 14.5)$

Hydraulic Pressure (MPa)	Cylinder Force (kN)	Clamping Force (kN)								Non-Usable Range (■)	Min. Lever Length (L) (mm)
		Lever Length L (mm)									
		L=22.5	L=27.5	L=33.5	L=40	L=50	L=60	L=80	L=100		
7	3.2			2.2	1.7	1.2	1.0	0.7	0.5	33.5	
6.5	3.0			2.1	1.6	1.1	0.9	0.6	0.5	31	
6	2.8			1.9	1.4	1.0	0.8	0.6	0.5	29	
5.5	2.5		2.5	1.8	1.3	1.0	0.8	0.5	0.4	27	
5	2.3		2.3	1.6	1.2	0.9	0.7	0.5	0.4	25	
4.5	2.1		2.1	1.4	1.1	0.8	0.6	0.5	0.4	24	
4	1.9	3.0	1.9	1.3	1.0	0.7	0.6	0.4	0.3	22	
3.5	1.6	2.6	1.6	1.1	0.9	0.6	0.5	0.4	0.3	21	
3	1.4	2.3	1.4	1.0	0.7	0.5	0.4	0.3	0.3	20	
2.5	1.2	1.9	1.2	0.8	0.6	0.5	0.4	0.3	0.2	20	
2	1.0	1.5	1.0	0.7	0.5	0.4	0.3	0.2	0.2	20	
1.5	0.7	1.2	0.7	0.5	0.4	0.3	0.2	0.2	0.2	20	
1	0.5	0.8	0.5	0.4	0.3	0.2	0.2	0.1	0.1	20	
0.5	0.3	0.4	0.3	0.2	0.2	0.1	0.1	0.1	0.1	20	
Max. Operating Pressure (MPa)	4.4	5.8	7.0	7.0	7.0	7.0	7.0	7.0	7.0		

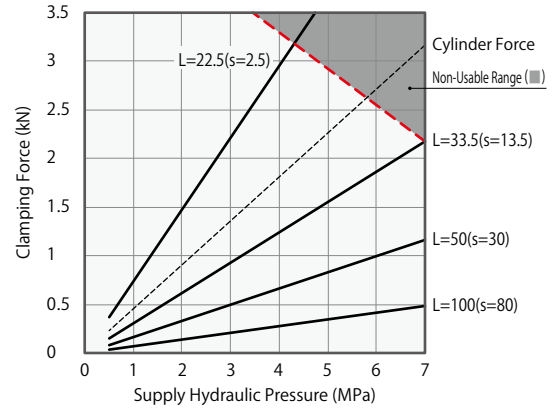

**LKK0400** - □ - □ Clamping Force Formula <sup>※1</sup> (kN)  $F = (7.64 \times P) / (L - 16)$

Hydraulic Pressure (MPa)	Cylinder Force (kN)	Clamping Force (kN)								Non-Usable Range (■)	Min. Lever Length (L) (mm)
		Lever Length L (mm)									
		L=25	L=30	L=36.5	L=40	L=50	L=60	L=80	L=100		
7	3.8			2.7	2.3	1.6	1.3	0.9	0.7	36.5	
6.5	3.5			2.5	2.1	1.5	1.2	0.8	0.6	34	
6	3.2			2.3	2.0	1.4	1.1	0.8	0.6	32	
5.5	3.0		3.1	2.2	1.8	1.3	1.0	0.7	0.6	29	
5	2.7		2.8	2.0	1.6	1.2	0.9	0.6	0.5	27	
4.5	2.4	3.9	2.5	1.8	1.5	1.1	0.8	0.6	0.5	26	
4	2.2	3.4	2.2	1.6	1.3	0.9	0.7	0.5	0.4	24	
3.5	1.9	3.0	2.0	1.4	1.2	0.8	0.7	0.5	0.4	23	
3	1.6	2.6	1.7	1.2	1.0	0.7	0.6	0.4	0.3	23	
2.5	1.4	2.2	1.4	1.0	0.8	0.6	0.5	0.3	0.3	23	
2	1.1	1.7	1.1	0.8	0.7	0.5	0.4	0.3	0.2	23	
1.5	0.8	1.3	0.9	0.6	0.5	0.4	0.3	0.2	0.2	23	
1	0.6	0.9	0.6	0.4	0.4	0.3	0.2	0.2	0.1	23	
0.5	0.3	0.5	0.3	0.2	0.2	0.2	0.1	0.1	0.1	23	
Max. Operating Pressure (MPa)	4.5	5.8	7.0	7.0	7.0	7.0	7.0	7.0	7.0		

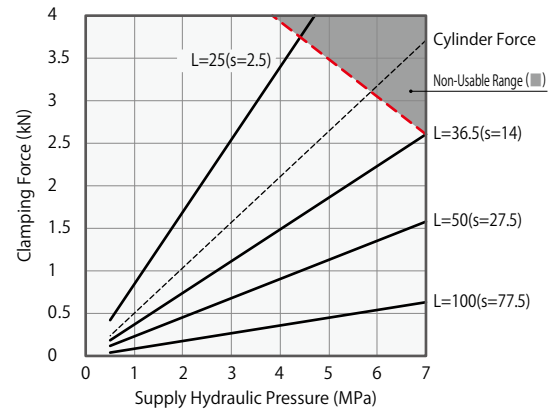

**LKK0480** - □ - □ Clamping Force Formula <sup>※1</sup> (kN)  $F = (11.76 \times P) / (L - 18.5)$

Hydraulic Pressure (MPa)	Cylinder Force (kN)	Clamping Force (kN)							Non-Usable Range (■)	Min. Lever Length (L) (mm)	
		Lever Length L (mm)									
		L=30	L=35	L=42	L=50	L=60	L=80	L=100	L=120		
7	5.0			3.6	2.7	2.0	1.4	1.1	0.9	42	
6.5	4.6			3.3	2.5	1.9	1.3	1.0	0.8	39	
6	4.3			3.1	2.3	1.8	1.2	0.9	0.7	36	
5.5	3.9		4.0	2.8	2.1	1.6	1.1	0.8	0.7	34	
5	3.6		3.6	2.6	1.9	1.5	1.0	0.8	0.6	32	
4.5	3.2	4.7	3.3	2.3	1.7	1.3	0.9	0.7	0.6	30	
4	2.9	4.1	2.9	2.1	1.5	1.2	0.8	0.6	0.5	28	
3.5	2.5	3.6	2.5	1.8	1.4	1.0	0.7	0.6	0.5	26	
3	2.2	3.1	2.2	1.6	1.2	0.9	0.6	0.5	0.4	26	
2.5	1.8	2.6	1.8	1.3	1.0	0.8	0.5	0.4	0.3	26	
2	1.5	2.1	1.5	1.1	0.8	0.6	0.4	0.3	0.3	26	
1.5	1.1	1.6	1.1	0.8	0.6	0.5	0.3	0.3	0.2	26	
1	0.8	1.1	0.8	0.6	0.4	0.3	0.2	0.2	0.2	26	
0.5	0.4	0.6	0.4	0.3	0.2	0.2	0.1	0.1	0.1	26	
Max. Operating Pressure (MPa)	4.8	5.9	7.0	7.0	7.0	7.0	7.0	7.0	7.0		

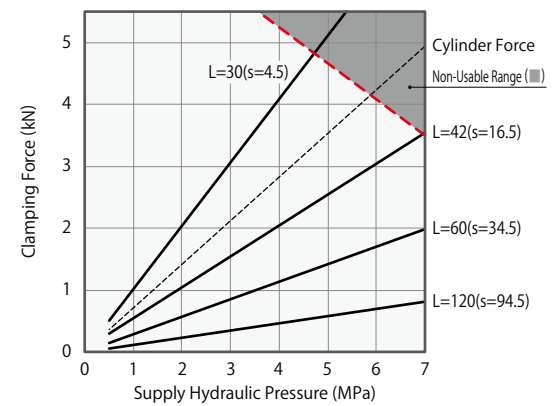

## Notes:

1. Tables and graphs show the relationship between the clamping force (kN) and supply hydraulic pressure (MPa).
2. Cylinder force (when L=0) cannot be calculated from the calculation formula of clamping force.
3. Operation in the non-usable range can damage the clamp and lead to fluid leakage.

※1. F : Clamping Force (kN), P : Supply Hydraulic Pressure (MPa), L : Lever Length (mm).

LKK0550 – □ – □		Clamping Force Formula ※1 (kN) $F = (18.18 \times P) / (L - 21)$									
Hydraulic Pressure (MPa)	Cylinder Force (kN)	Clamping Force (kN)								Non-Usable Range (■)	Min. Lever Length (L) (mm)
		Lever Length L (mm)									
		L=35	L=40	L=50	L=60	L=70	L=80	L=100	L=120		
7	6.8			4.4	3.3	2.6	2.2	1.7	1.3		50
6.5	6.3			4.1	3.1	2.5	2.1	1.5	1.2		46
6	5.8			3.8	2.8	2.3	1.9	1.4	1.2		43
5.5	5.3		5.3	3.5	2.6	2.1	1.7	1.3	1.1		39
5	4.9		4.8	3.2	2.4	1.9	1.6	1.2	1.0		37
4.5	4.4	5.9	4.4	2.9	2.1	1.7	1.4	1.1	0.9		34
4	3.9	5.2	3.9	2.6	1.9	1.5	1.3	1.0	0.8		32
3.5	3.4	4.6	3.4	2.2	1.7	1.3	1.1	0.9	0.7		30
3	2.9	3.9	2.9	1.9	1.4	1.2	1.0	0.7	0.6		30
2.5	2.5	3.3	2.4	1.6	1.2	1.0	0.8	0.6	0.5		30
2	2.0	2.6	2.0	1.3	1.0	0.8	0.7	0.5	0.4		30
1.5	1.5	2.0	1.5	1.0	0.7	0.6	0.5	0.4	0.3		30
1	1.0	1.3	1.0	0.7	0.5	0.4	0.4	0.3	0.2		30
0.5	0.5	0.7	0.5	0.4	0.3	0.2	0.2	0.2	0.1		30
Max. Operating Pressure (MPa)		4.8	5.7	7.0	7.0	7.0	7.0	7.0	7.0		

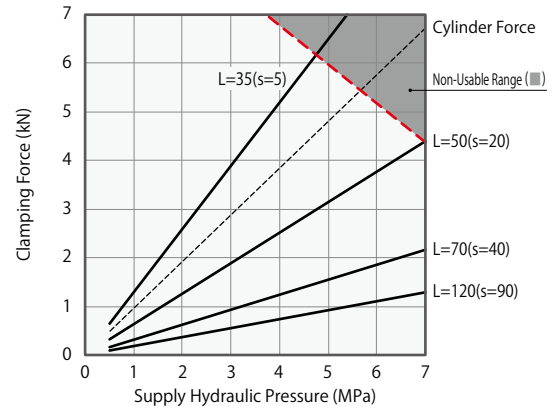

LKK0650 – □ – □		Clamping Force Formula ※1 (kN) $F = (35.06 \times P) / (L - 24.5)$									
Hydraulic Pressure (MPa)	Cylinder Force (kN)	Clamping Force (kN)						Non-Usable Range (■)	Min. Lever Length (L) (mm)		
		Lever Length L (mm)									
		L=40	L=50	L=56.5	L=80	L=100	L=120	L=140	L=160		
7	11.2			7.7	4.5	3.3	2.6	2.2	1.9		56.5
6.5	10.4			7.2	4.2	3.1	2.4	2.0	1.7		52
6	9.6		8.3	6.6	3.8	2.8	2.3	1.9	1.6		48
5.5	8.8		7.6	6.1	3.5	2.6	2.1	1.7	1.5		45
5	8.0		6.9	5.5	3.2	2.4	1.9	1.6	1.3		42
4.5	7.2	10.2	6.2	5.0	2.9	2.1	1.7	1.4	1.2		39
4	6.4	9.1	5.5	4.4	2.6	1.9	1.5	1.3	1.1		37
3.5	5.6	8.0	4.9	3.9	2.3	1.7	1.3	1.1	1.0		35
3	4.8	6.8	4.2	3.3	1.9	1.4	1.2	1.0	0.8		35
2.5	4.0	5.7	3.5	2.8	1.6	1.2	1.0	0.8	0.7		35
2	3.2	4.6	2.8	2.2	1.3	1.0	0.8	0.7	0.6		35
1.5	2.4	3.4	2.1	1.7	1.0	0.7	0.6	0.5	0.4		35
1	1.6	2.3	1.4	1.1	0.7	0.5	0.4	0.4	0.3		35
0.5	0.8	1.2	0.7	0.6	0.4	0.3	0.2	0.2	0.2		35
Max. Operating Pressure (MPa)		4.8	6.3	7.0	7.0	7.0	7.0	7.0	7.0		

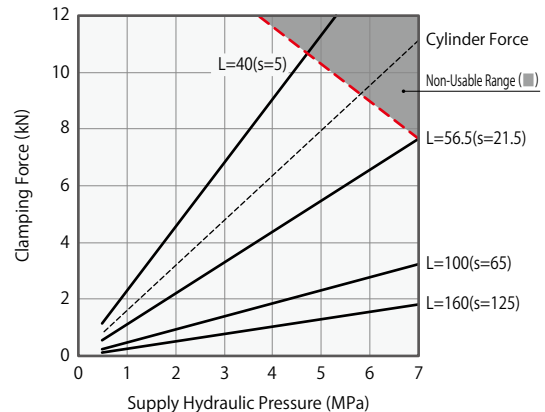

LKK0750 – □ – □		Clamping Force Formula ※1 (kN) $F = (64.14 \times P) / (L - 30)$									
Hydraulic Pressure (MPa)	Cylinder Force (kN)	Clamping Force (kN)						Non-Usable Range (■)	Min. Lever Length (L) (mm)		
		Lever Length L (mm)									
		L=50	L=60	L=67.5	L=80	L=100	L=120	L=140	L=160		
7	16.7			12.0	9.0	6.5	5.0	4.1	3.5		67.5
6.5	15.5			11.2	8.4	6.0	4.7	3.8	3.3		63
6	14.3		12.9	10.3	7.7	5.5	4.3	3.5	3.0		58
5.5	13.1		11.8	9.5	7.1	5.1	4.0	3.3	2.8		54
5	11.9	16.1	10.7	8.6	6.5	4.6	3.6	3.0	2.5		51
4.5	10.7	14.5	9.7	7.7	5.8	4.2	3.3	2.7	2.3		48
4	9.6	12.9	8.6	6.9	5.2	3.7	2.9	2.4	2.0		45
3.5	8.4	11.3	7.5	6.0	4.5	3.3	2.5	2.1	1.8		43
3	7.2	9.7	6.5	5.2	3.9	2.8	2.2	1.8	1.5		43
2.5	6.0	8.1	5.4	4.3	3.3	2.3	1.8	1.5	1.3		43
2	4.8	6.5	4.3	3.5	2.6	1.9	1.5	1.2	1.0		43
1.5	3.6	4.9	3.3	2.6	2.0	1.4	1.1	0.9	0.8		43
1	2.4	3.3	2.2	1.8	1.3	1.0	0.8	0.6	0.5		43
0.5	1.2	1.7	1.1	0.9	0.7	0.5	0.4	0.3	0.3		43
Max. Operating Pressure (MPa)		5.0	6.3	7.0	7.0	7.0	7.0	7.0	7.0		

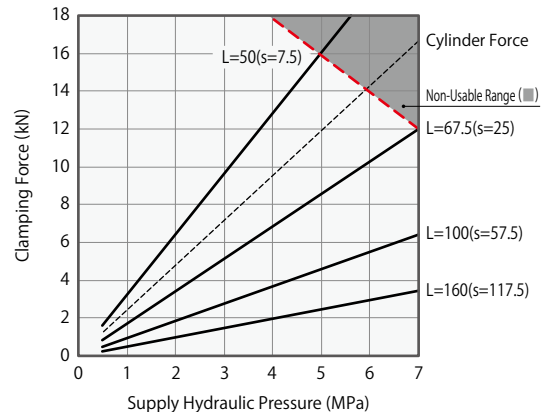



External Dimensions

C : Gasket Option (With G Thread Plug)

※The drawing shows the locked state of LKK-C.

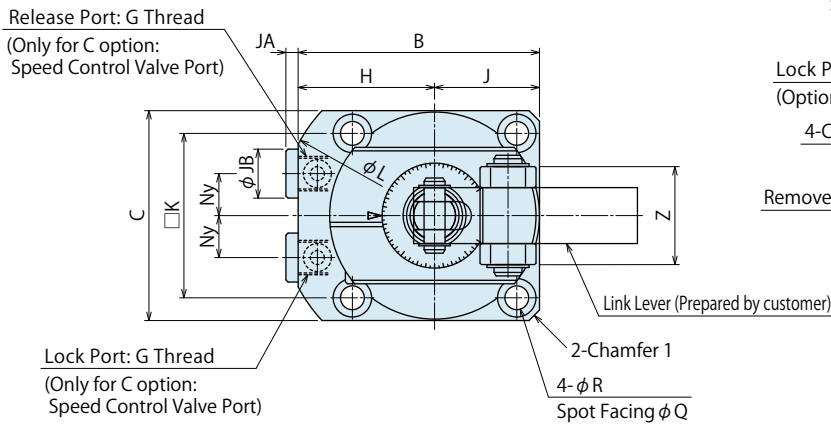

Release Port: G Thread  
(Only for C option:  
Speed Control Valve Port)

Lock Port: G Thread  
(Only for C option:  
Speed Control Valve Port)

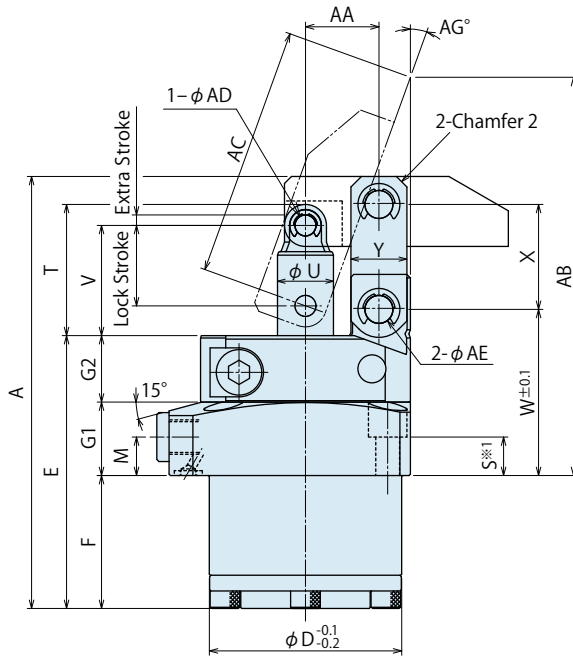

Lock Port : O-ring (Included)  
(-C option)

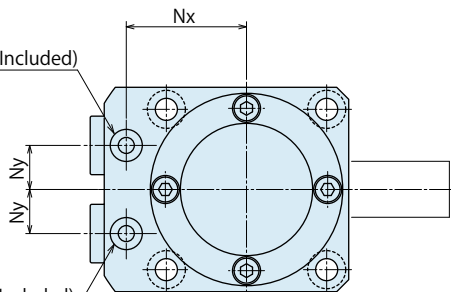

Release Port : O-ring (Included)  
(-C option)

Machining Dimensions of Mounting Area

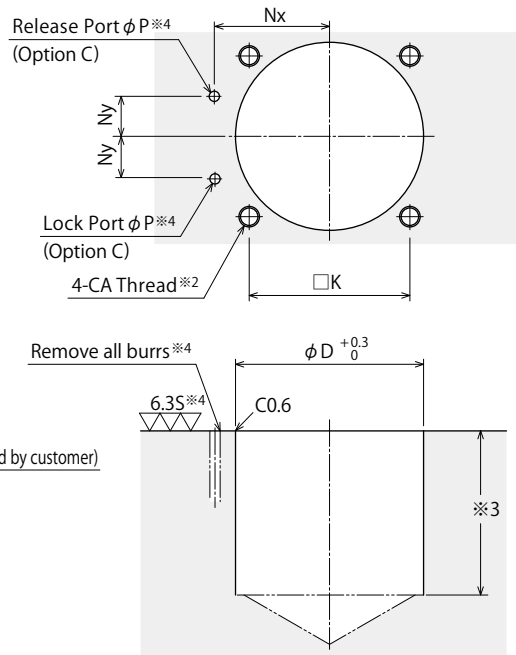

Notes :

- ※ 2. CA tapping depth of the mounting bolt should be decided according to the mounting height referring to dimension 'S'.
- ※ 3. The depth of the body mounting hole φD should be decided according to the mounting height referring to dimension 'F'.
- ※ 4. The machining dimension is for -C : Gasket Option.

Piping Method

S : Piping Option (Rc Thread)

※The drawing shows the locked state of LKK-S.

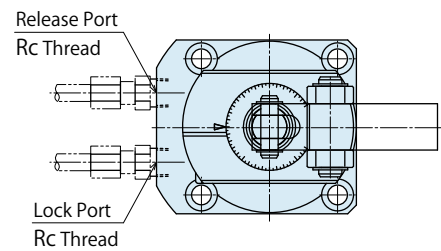

Notes :

- ※ 1. Mounting bolts are not provided. Please prepare them according to the mounting height referring to dimension 'S'.
  1. Please use the attached pin (equivalent to φADf6, φAEf6, HRC60) as the mounting pin for lever.
  2. Speed control valve is sold separately. Please refer to P.15.



## Model No. Indication

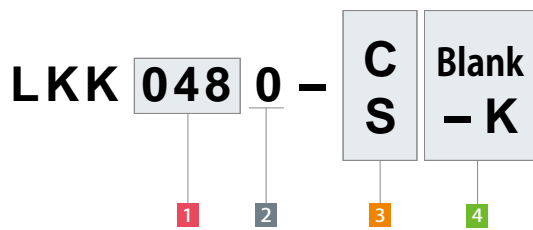

(Format Example : LKK0550-C, LKK0750-S-K)

- 1 Body Size
- 2 Design No.
- 3 Piping Method
- 4 Option

Note :

1. For option -K, the flange pin is used as a link pin (3 parts) and the C type circlip is used as a stop ring.

## External Dimensions and Machining Dimensions for Mounting

(mm)

Model No.	LKK0360-□-□	LKK0400-□-□	LKK0480-□-□	LKK0550-□-□	LKK0650-□-□	LKK0750-□-□
Full Stroke	18.5	20.5	23.5	26	29.5	35
Lock Stroke	16	17.5	20.5	23	26.5	32
Extra Stroke	2.5	3	3	3	3	3
A	88.5	99.5	112	123.5	144.5	169
B	49	54	61	69	81	94.5
C	40	45	51	60	70	85
D	36	40	48	55	65	75
E	58	66	73	78	90.5	102
F	23	29	33	38	43.5	50
G1	21	21	22	21	26	26
G2	14	16	18	19	21	26
H	29	31.5	35.5	39	46	52
J	20	22.5	25.5	30	35	42.5
K	31.4	34	40	47	55	63
L	66	72	81	88	106	116
M	11	11	11	11	13	13
Nx	23.5	26	30	33.5	39.5	45
Ny	8	9	11	12	15	16
P	3	3	3	3	5	5
Q	7.5	9	9	11	11	14
R	4.5	5.5	5.5	6.8	6.8	9
S	14.5	13	14	11	16	14
T	27	30.5	35	37.5	45	55
U	10	12	14	16	20	22
V	22.5	25	29	31.5	37	45
W	40	42.5	46.5	47.5	56	63
X	20	22	26	30	35.5	43.5
Y	11	13	13	16	19	25
Z	19	21	24	28	37	40
Chamfer 1	C2	C3	C3	C3	C4	C10
Chamfer 2	C2.5	C3	C3	C3	C5	C5
AA	14.5	16	18.5	21	24.5	30
AB	84.3	89.7	104.4	113.9	128.4	145.8
AC	47.1	50.2	61.2	71.7	78.7	90.8
AD	5	6	6	6	8	10
AE	5	6	6	8	10	12
AG	19.6	20.2	18.9	19.9	20.5	21.4
CA	M4×0.7	M5×0.8	M5×0.8	M6×1	M6×1	M8×1.25
JA	3.5	3.5	3.5	3.5	4.5	4.5
JB	14	14	14	14	19	19
Lock/ Release Port	Option C	G1/8	G1/8	G1/8	G1/4	G1/4
	Option S	Rc1/8	Rc1/8	Rc1/8	Rc1/4	Rc1/4
O-ring (Option C)	1BP5	1BP5	1BP5	1BP5	1BP7	1BP7



## Model No. Indication

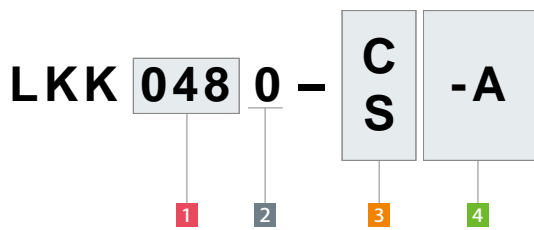

(Format Example : LKK0550-C-A, LKK0750-S-A)

- 1 Body Size
- 2 Design No.
- 3 Piping Method
- 4 Option

Note :

1. When selecting 4 option A, unlike Blank/K, the lever mounting pin is not included. The dimensions of clamp body are the same as Blank/K.

## External Dimensions and Machining Dimensions for Mounting

(mm)

Model No.	LKK0360-□-A	LKK0400-□-A	LKK0480-□-A	LKK0550-□-A	LKK0650-□-A	LKK0750-□-A	
Full Stroke	18.5	20.5	23.5	26	29.5	35	
Lock Stroke	16	17.5	20.5	23	26.5	32	
Extra Stroke	2.5	3	3	3	3	3	
A	91.5	103	115.5	127.5	148.5	174	
B	49	54	61	69	81	94.5	
C	40	45	51	60	70	85	
D	36	40	48	55	65	75	
E	58	66	73	78	90.5	102	
F	23	29	33	38	43.5	50	
G1	21	21	22	21	26	26	
G2	14	16	18	19	21	26	
H	29	31.5	35.5	39	46	52	
J	20	22.5	25.5	30	35	42.5	
K	31.4	34	40	47	55	63	
L	66	72	81	88	106	116	
M	11	11	11	11	13	13	
Nx	23.5	26	30	33.5	39.5	45	
Ny	8	9	11	12	15	16	
P	3	3	3	3	5	5	
Q	7.5	9	9	11	11	14	
R	4.5	5.5	5.5	6.8	6.8	9	
S	14.5	13	14	11	16	14	
T	27	30.5	35	37.5	45	55	
U	10	12	14	16	20	22	
V	22.5	25	29	31.5	37	45	
W	40	42.5	46.5	47.5	56	63	
X	20	22	26	30	35.5	43.5	
Y	11	13	13	16	19	25	
Z	19	21	24	28	37	40	
Chamfer 1	C2	C3	C3	C3	C4	C10	
Chamfer 2	C2.5	C3	C3	C3	C5	C5	
AA	14.5	16	18.5	21	24.5	30	
AB	84.3	89.7	104.4	113.9	128.4	145.8	
AC	47.1	50.2	61.2	71.7	78.7	90.8	
AD	5	6	6	6	8	10	
AE	5	6	6	8	10	12	
AG	19.6	20.2	18.9	19.9	20.5	21.4	
CA	M4×0.7	M5×0.8	M5×0.8	M6×1	M6×1	M8×1.25	
SA	3	3	3	3	4	4	
SB	24	26	30	35	45	50	
SC	21	24	26	29	34.5	43	
SD	10.5	11.5	13	17	20	25	
SE	11	12.5	13	16.5	18.5	23	
SF	M3×0.5×6	M3×0.5×6	M3×0.5×6	M3×0.5×8	M4×0.7×8	M4×0.7×10	
SG	3.5	4	5.5	7	8.5	9.5	
JA	3.5	3.5	3.5	3.5	4.5	4.5	
JB	14	14	14	14	19	19	
Lock/ Release Port	Option C	G1/8	G1/8	G1/8	G1/8	G1/4	G1/4
	Option S	Rc1/8	Rc1/8	Rc1/8	Rc1/8	Rc1/4	Rc1/4
O-ring (Option C)	1BP5	1BP5	1BP5	1BP5	1BP7	1BP7	

● Link Lever Design Dimensions

※ Reference for designing link lever.

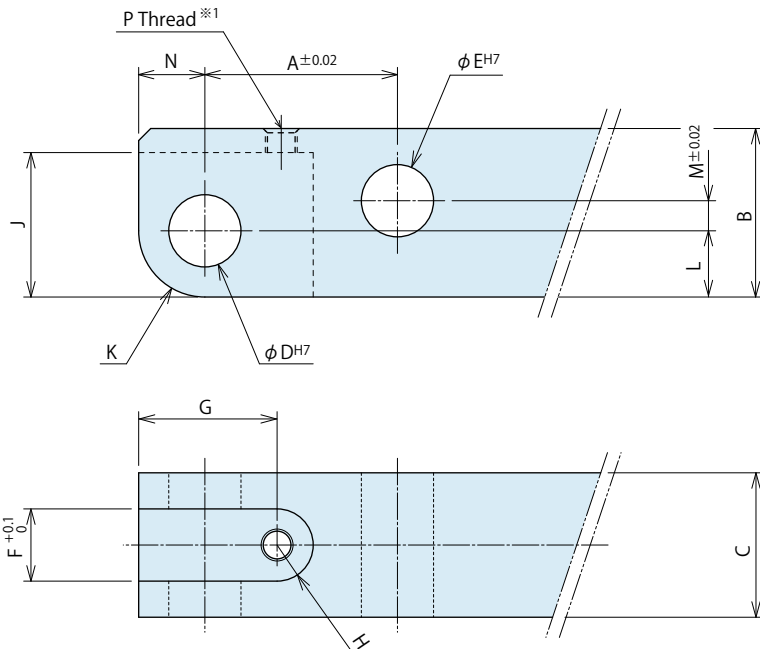
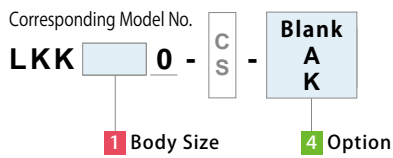

● Link Lever Design Dimension List

(mm)

Corresponding Model No.	LKK0360	LKK0400	LKK0480	LKK0550	LKK0650	LKK0750
A	14.5	16	18.5	21	24.5	30
B	12.5	14	16	20	25	32
C	10 <sub>-0.2</sub> <sup>0</sup>	12 <sub>-0.3</sub> <sup>0</sup>	12 <sub>-0.3</sub> <sup>0</sup>	16 <sub>-0.3</sub> <sup>0</sup>	19 <sub>-0.3</sub> <sup>0</sup>	22 <sub>-0.3</sub> <sup>0</sup>
D	5 <sub>0</sub> <sup>+0.012</sup>	6 <sub>0</sub> <sup>+0.012</sup>	6 <sub>0</sub> <sup>+0.012</sup>	6 <sub>0</sub> <sup>+0.012</sup>	8 <sub>0</sub> <sup>+0.015</sup>	10 <sub>0</sub> <sup>+0.015</sup>
E	5 <sub>0</sub> <sup>+0.012</sup>	6 <sub>0</sub> <sup>+0.012</sup>	6 <sub>0</sub> <sup>+0.012</sup>	8 <sub>0</sub> <sup>+0.015</sup>	10 <sub>0</sub> <sup>+0.015</sup>	12 <sub>0</sub> <sup>+0.018</sup>
F	5	6	6	8	10	11
G	10	11.5	13	12.5	16	20
H	R2.5	R3	R3	R4	R5	R5.5
J	10	12	13	13	17.5	22
K	R4.5	R5.5	R6	R6	R8	R10
L	4.5	5.5	6	6	8	10
M	2.5	2.5	3.5	6	7.5	9.5
N	4.5	5.5	6	6	8	10
P (Nominal×Depth) <sup>※1</sup>	M3×0.5 Through	M3×0.5 Through	M3×0.5 Through	M3×0.5×6	M4×0.7 Through	M4×0.7×7

Notes :

1. Link lever should be designed with its length according to performance curve.
2. If the link lever is not in accordance with the dimension shown above, its performance may be degraded, and damage can occur.
3. For 4 Option **Blank/K**, use the attached pin (equivalent to  $\phi ADf6$ ,  $\phi AEf6$ , HRC60) as the lever mounting pin.  
(Refer to external dimensions of the clamp body for the dimensions of  $\phi AD$ ,  $\phi AE$ .)
4. For 4 Option **A**, the lever mounting pin is not included in the clamp.  
Please order Tightening Kit for Quick Change Lever Type A (LZK□-W).

※1. Machining of P Thread is required only when using Tightening Kit for Quick Change Lever Type A (LZK□-W).

## Accessory : Material Link Lever

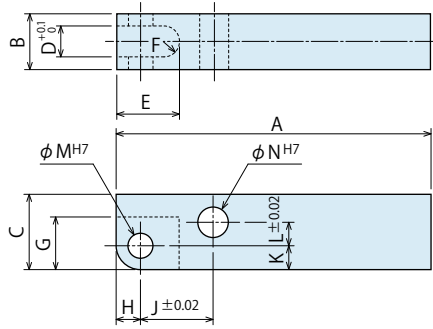

Model No. Indication

**LZK 048 0 - L**

Size (Refer to the table.) Design No. (Revision Number)

(mm)

Model No.	LZK0360-L	LZK0400-L	LZK0480-L	LZK0550-L	LZK0650-L	LZK0750-L
Corresponding Model No.	LKK0360	LKK0400	LKK0480	LKK0550	LKK0650	LKK0750
A	65	75	85	90	105	110
B	10 <sup>0</sup> <sub>-0.2</sub>	12 <sup>0</sup> <sub>-0.3</sub>	12 <sup>0</sup> <sub>-0.3</sub>	16 <sup>0</sup> <sub>-0.3</sub>	19 <sup>0</sup> <sub>-0.3</sub>	22 <sup>0</sup> <sub>-0.3</sub>
C	12.5	14	16	20	25	32
D	5	6	6	8	10	11
E	12.5	14.5	16	16.5	21	25.5
F	R2.5	R3	R3	R4	R5	R5.5
G	10	12	13	13	17.5	22
H	4.5	5.5	6	6	8	10
J	14.5	16	18.5	21	24.5	30
K	4.5	5.5	6	6	8	10
L	2.5	2.5	3.5	6	7.5	9.5
M	5 <sup>+0.012</sup> <sub>0</sub>	6 <sup>+0.012</sup> <sub>0</sub>	6 <sup>+0.012</sup> <sub>0</sub>	6 <sup>+0.012</sup> <sub>0</sub>	8 <sup>+0.015</sup> <sub>0</sub>	10 <sup>+0.015</sup> <sub>0</sub>
N	5 <sup>+0.012</sup> <sub>0</sub>	6 <sup>+0.012</sup> <sub>0</sub>	6 <sup>+0.012</sup> <sub>0</sub>	8 <sup>+0.015</sup> <sub>0</sub>	10 <sup>+0.015</sup> <sub>0</sub>	12 <sup>+0.018</sup> <sub>0</sub>

Notes :

- Material S45C Surface Finishing : Alkaline Blackening
- If necessary, the front end should be additionally machined.
- For **4** Option **Blank/K**, use the attached pin (equivalent to  $\phi ADf6$ ,  $\phi AEf6$ , HRC60) as the lever mounting pin.
- For **4** Option **A**, the lever mounting pin is not included in the clamp.  
Please order Tightening Kit for Quick Change Lever Type A (LZK□-W).
- When using Tightening Kit for Quick Change Lever Type A (LZK□-W), a tapped hole should be additionally machined.  
Refer to the link lever design dimensions (P Thread part) for additional machining.

## Accessory : Tightening Kit for Quick Change Lever Type A

Model No. Indication

**LZK 040 0 - W**

Size (Refer to the table.) Design No. (Revision Number)

Tightening Kit for mounting Quick Change Lever Type A.  
Sold separately from clamp body.

【Contents of Tightening Kit】

- Cover (with Bolt)
- Rod Pin
- Lever Pin

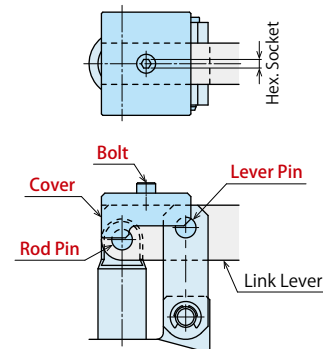

Model No.	LZK0360-W	LZK0400-W	LZK0480-W	LZK0550-W	LZK0650-W	LZK0750-W
Corresponding Model No.	LKK0360-□-A	LKK0400-□-A	LKK0480-□-A	LKK0550-□-A	LKK0650-□-A	LKK0750-□-A
Nominal×Pitch of Bolt	M3×0.5	M3×0.5	M3×0.5	M3×0.5	M4×0.7	M4×0.7
Hex. Socket mm	2.5	2.5	2.5	2.5	3	3
Tightening Torque N·m	1.3	1.3	1.3	1.3	3.2	3.2

Manifold Block

Model No. Indication

**LZY 048 0 - MD**

Size  
(Refer to the table.)

Design No.  
(Revision Number)

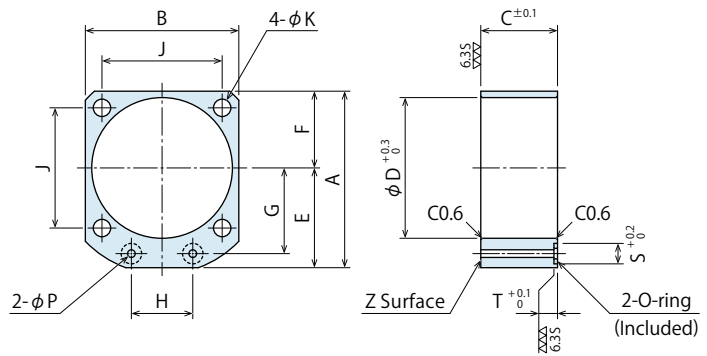

(mm)

Model No.	LZY0360-MD	LZY0400-MD	LZY0480-MD	LZY0550-MD	LZY0650-MD	LZY0750-MD
Corresponding Model No.	LKK0360	LKK0400	LKK0480	LKK0550	LKK0650	LKK0750
A	49	54	61	69	81	92
B	40	45	51	60	70	80
C	20	20	27	30	32	37
D	36	40	48	55	65	75
E	29	31.5	35.5	39	46	52
F	20	22.5	25.5	30	35	40
G	23.5	26	30	33.5	39.5	45
H	16	18	22	24	30	32
J	31.4	34	40	47	55	63
K	4.5	5.5	5.5	6.8	6.8	9
P	3	3	3	3	5	5
S	8	8	8	8	10	10
T	1.4	1.4	1.4	1.4	1.4	1.4
O-ring	1BP5	1BP5	1BP5	1BP5	1BP7	1BP7
Mass kg	0.2	0.2	0.3	0.4	0.5	0.8

- Notes :
1. Material: S45C Surface Finishing: Alkaline Blackening
  2. Mounting bolts are not included. Prepare mounting bolts according to the mounting height using the dimension C as a reference.
  3. If other than the block thickness (dimension C) is required, machine surface Z additionally. Or, design a manifold block based on this drawing and perform surface finishing as necessary.

 **MEMO**



## Model No. Indication (Speed Control Valve for Low Pressure)

**BZL 0 10 1 - B**

10
1
B

1
2
3



### 1 G Thread Size

**10** : Thread Part G1/8A Thread

**20** : Thread Part G1/4A Thread

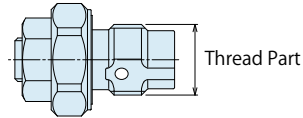

### 2 Design No.

**1** : Revision Number

### 3 Control Method

**B** : Meter-out

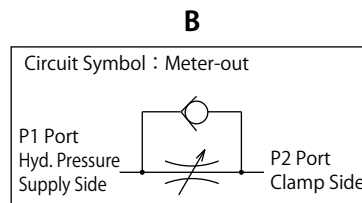

## Specifications

Model No.		BZL0101-B	BZL0201-B
Max. Operating Pressure	MPa	7	
Withstanding Pressure	MPa	10.5	
Control Method		Meter-out	
G Thread Size		G1/8A	G1/4A
Cracking Pressure	MPa	0.12	
Max. Passage Area	mm <sup>2</sup>	2.6	5.0
Usable Fluid		General Hydraulic Oil Equivalent to ISO-VG-32	
Operating Temperature	°C	0 ~ 70	
Tightening Torque for Main Body	N·m	10	25
Mass	g	12	26

Notes : 1. It must be mounted with a recommended torque. Because of the structure of the metal seal, the flow control valve may not be able to adjust the flow rate, if mounting torque is insufficient.  
2. Do not attach a used BZL to other cylinders.

Flow control may not be done because the difference of the depth of G thread makes metal sealing insufficient.

## Applicable Products

Model No.	LKK (Double Action) Universal Clamp
<b>BZL0101-B</b>	LKK0360-C-□
	LKK0400-C-□
	LKK0480-C-□
	LKK0550-C-□
<b>BZL0201-B</b>	LKK0650-C-□
	LKK0750-C-□

Note : 1. Flow control circuit for double acting cylinder should have meter-out circuits for both the lock and release sides.  
Meter-in control can have adverse effect by presence of air in the system.

## Flow Rate Graph < Hydraulic Fluids ISO-VG32 (25~35°C) >

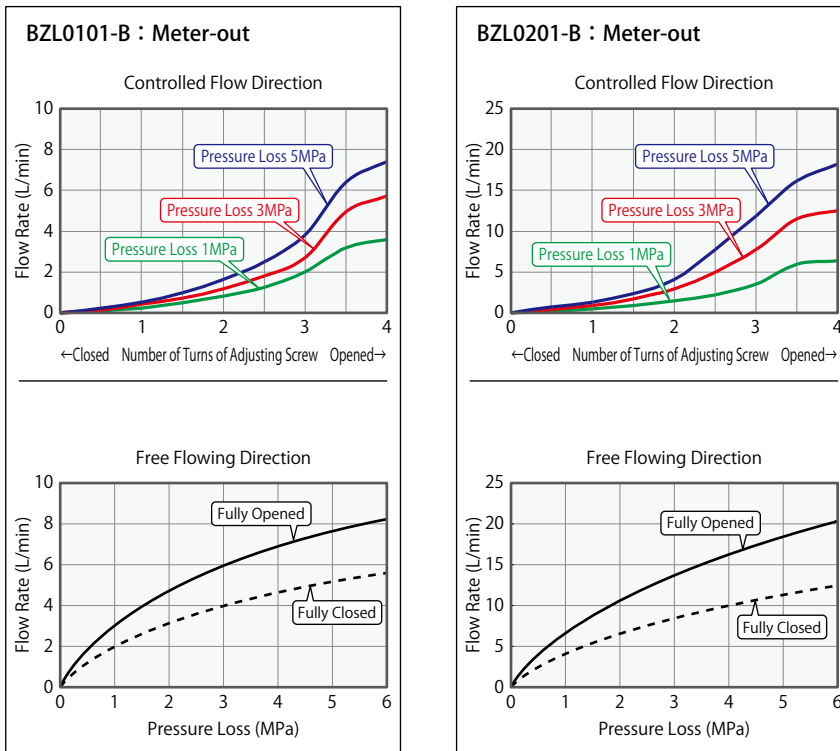

## External Dimensions

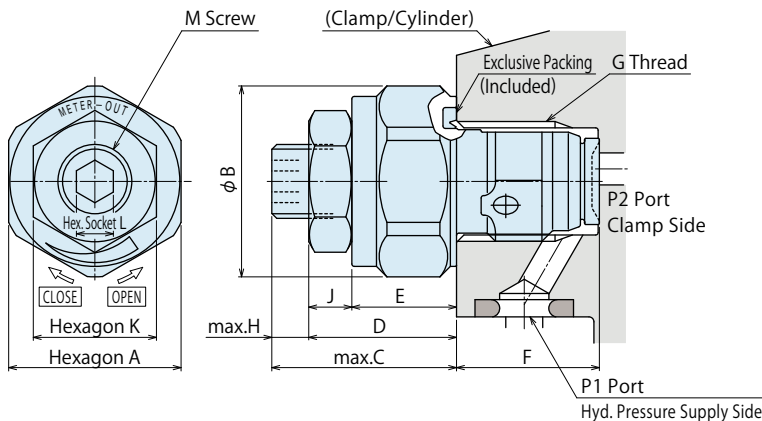

Model No.	BZL0101-B	BZL0201-B
A	14	18
B	15.5	20
C	15	16
D	12	13
E	8.5	9.5
F	(11.6)	(15.1)
G	G1/8	G1/4
H	3	3
J	3.5	3.5
K	10	10
L	3	3
M	M6×0.75	M6×0.75
N	11.5	15
P	8.5	11 <sup>*1</sup>
Q	9	11.5
R (Flat Surface Area)	16	20.5
S	10	13.5
T	8.7	11.5
U	G1/8	G1/4
V	2 ~ 3	3 ~ 4
W	2.5 ~ 5	3.5 ~ 7

## Machining Dimensions of Mounting Area

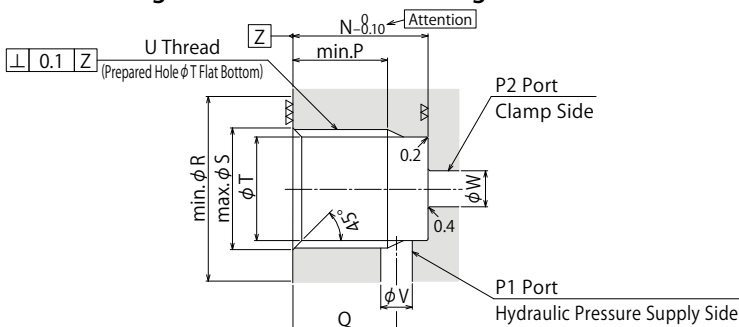

Notes :

1. Since the  $\nabla\nabla\nabla$  area is a sealing part, be careful not to damage it.
2. Since the  $\nabla\nabla$  area is the metal sealing part of BZL, be careful not to damage it. (Especially when deburring)
3. No cutting chips or burr should be at the tolerance part of machining hole.
4. As shown in the drawing, P1 port is used as the hydraulic supply and P2 port as the clamp side.
5. If mounting plugs or fittings with G thread specification available in the market, the dimension '<sup>\*</sup>1' should be 12.5.

## Notes

1. Please read "Notes on Hydraulic Cylinder Speed Control Circuit" to assist with a proper hydraulic circuit design.  
If there is an issue of the circuit design, it leads to malfunctions and damages on the applications. (Refer to P.21)
2. Air bleeding under high pressure is dangerous. It must be done under low pressure. (Refer to: the minimum operating range of the product within the circuit.)

Model No. Indication (Air Bleed Valve)

**BZX0 1 0**

1 2



**1 G Thread Size**

- 1 : Thread Part G1/8A Thread
- 2 : Thread Part G1/4A Thread

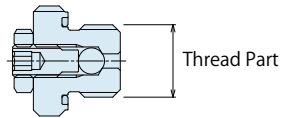

**2 Design No.**

- 0 : Revision Number

Specifications

Model No.	BZX010	BZX020
Max. Operating Pressure MPa	25	
Withstanding Pressure MPa	37.5	
G Thread Size	G1/8A	G1/4A
Usable Fluid	General Hydraulic Oil Equivalent to ISO-VG-32	
Operating Temperature °C	0 ~ 70	
Tightening Torque for Main Body N·m	10	25
Mass g	12	23

Circuit Symbol

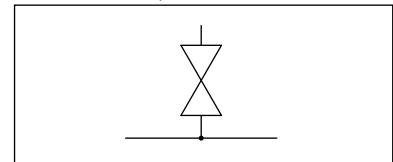

- Notes :
1. Do not over loosen the plug during air bleeding.  
(Do not loosen for more than 2 turns from the fully closed position.)
  2. Air bleeding under high pressure is dangerous. It must be done under low pressure.  
(Refer to: the minimum operating range of the product within the circuit.)
  3. Refer to the machining dimensions for BZL mounting area.

Applicable Products

Model No.	LKK (Double Action) Universal Clamp
<b>BZX010</b>	LKK0360-C-□
	LKK0400-C-□
	LKK0480-C-□
	LKK0550-C-□
<b>BZX020</b>	LKK0650-C-□
	LKK0750-C-□

External Dimensions

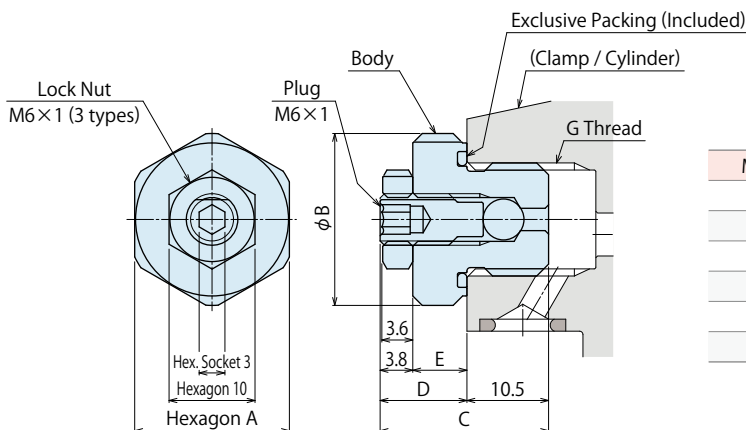

Model No.	BZX010	BZX020
A	14	18
B	15.5	20
C	19.8	20.6
D	9.3	10.1
E	5.5	6.3
G	G1/8	G1/4

## Model No. Indication (G Thread Plug with Air Bleeding Function)

# JZG0 1 0

1 2



### 1 G Thread Size

- 1 : Thread Part G1/8A Thread
- 2 : Thread Part G1/4A Thread

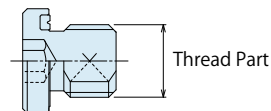

### 2 Design No.

- 0 : Revision Number

## Specifications

Model No.	JZG010	JZG020
Max. Operating Pressure MPa	35	
Withstanding Pressure MPa	42	
G Thread Size	G1/8A	G1/4A
Usable Fluid	General Hydraulic Oil Equivalent to ISO-VG-32	
Operating Temperature °C	0 ~ 70	
Tightening Torque for Main Body N·m	10	25
Mass g	7	15

- Notes :
1. Air bleeding under high pressure is dangerous. It must be done under low pressure. (Refer to: the minimum operating range of the product within the circuit.)
  2. Refer to the machining dimensions for BZL mounting area.

## Applicable Products

Model No.	LKK (Double Action) Universal Clamp
<b>JZG010</b>	LKK0360-C-□
	LKK0400-C-□
	LKK0480-C-□
	LKK0550-C-□
<b>JZG020</b>	LKK0650-C-□
	LKK0750-C-□

## External Dimensions

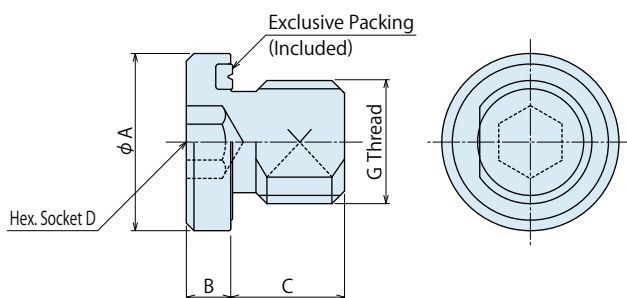

Model No.	JZG010	JZG020
A	14	18
B	3.5	4.5
C	8	9
D	5	6
G	G1/8A	G1/4A

**Cautions**

● Notes for Design

- 1) Check Specifications
  - Please use each product according to the specifications.
- 2) Notes for Circuit Design
  - Please read "Notes on Hydraulic Cylinder Speed Control Unit" to assist with proper hydraulic circuit designing. Improper circuit design may lead to malfunctions and damages. (Refer to P.21)
  - Ensure there is no possibility of supplying hydraulic pressure to the lock and release ports simultaneously.
- 3) Notes for Link Lever Design
  - Make sure no force is applied to the piston rod except from the axial direction. (Make sure the clamp surface and the mounting surface on the workpiece are parallel.) The usage like the one shown in the drawing below will apply a large bending stress to the piston rod and must be avoided.

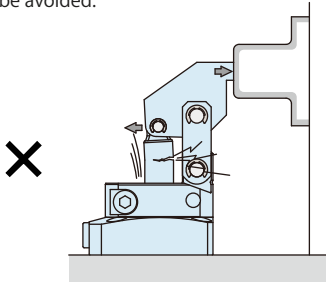

- Offset levers cannot be used. Offset loads will damage the product.

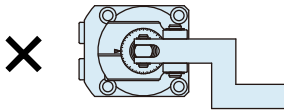

- 4) When using on a welding fixture, the exposed area of the piston rod and the link plate should be protected.
  - If spatter gets onto sliding surfaces, it could lead to malfunctions and fluid leakage.
- 5) When clamping on a sloped surface of the workpiece
  - Make sure the clamp surface and mounting surface of the clamp are parallel.

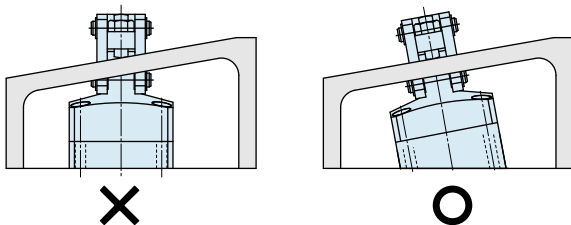

- 6) When using in a dry environment.
  - The link pin can be dried out. Grease it periodically or use a special pin. Contact us for the specifications for special pins.

● Installation Notes

- 1) Check the Usable Fluid
  - Please use the appropriate fluid by referring to the Hydraulic Fluid List (P.20).
- 2) Installation of the Product
  - Use hexagon socket bolts as multiple bolt holes for mounting (with tensile strength of 12.9) and tighten them with the torque shown in the table below. Tightening with greater torque than recommended can depress the seating surface or break the bolt.

Model No.	Tightening Bolt Size	Tightening Torque (N·m)
LKK0360	M4×0.7	4.0
LKK0400	M5×0.8	8.0
LKK0480	M5×0.8	8.0
LKK0550	M6×1	14
LKK0650	M6×1	14
LKK0750	M8×1.25	33

3) Installation / Removal of the Link Lever

- When inserting the link pin, do not hit the pin directly with a hammer. When using a hammer to insert the pin, always use a cover plate with a smaller diameter than the snap ring groove on the pin.

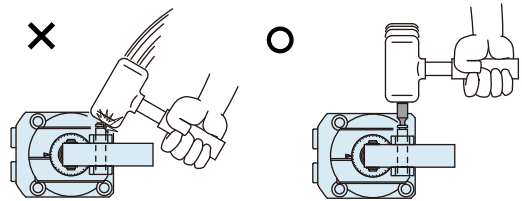

- Tighten the bolt of Quick Change Lever Type A with the torque shown below.

Quick Change Lever Type A

Model No.	Tightening Bolt Size	Tightening Torque (N·m)
LKK0360-□-A	M3×0.5	1.3
LKK0400-□-A	M3×0.5	1.3
LKK0480-□-A	M3×0.5	1.3
LKK0550-□-A	M3×0.5	1.3
LKK0650-□-A	M4×0.7	3.2
LKK0750-□-A	M4×0.7	3.2

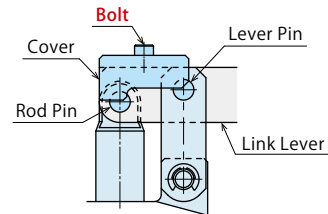

#### 4) Fixing and Releasing of the Pivot Block

- Fix the pivot block by tightening the lock bolt with the torque shown in the table below.

Model No.	Lock Bolt Size	Tightening Torque (N·m)
LKK0360	M5×0.8	7.5
LKK0400	M6×1	14
LKK0480	M6×1	14
LKK0550	M8×1.25	33
LKK0650	M10×1.5	65
LKK0750	M12×1.75	100 ~ 114

- Release the pivot block by loosening the lock bolt.  
If the pivot block is firmly fixed due to coolant and so on, release it by screwing a hollow set into the fixing releasing screw.

Model No.	Fixing Releasing Screw Size
LKK0360	M2.5×0.45
LKK0400	M2.5×0.45
LKK0480	M3×0.5
LKK0550	M3×0.5
LKK0650	M4×0.7
LKK0750	M4×0.7

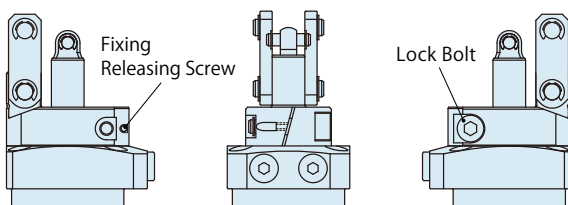

#### 5) Speed Adjustment

- Adjust the speed to make the total operating time one second or more. If the clamp operates too fast the parts will wear out leading to premature damage and ultimately complete equipment failure.
- Please make sure to release air from the circuit before adjusting speed. It will be difficult to adjust the speed accurately if the air is filled in the circuit.
- Turn the speed control valve gradually from the low-speed side (small flow) to the high-speed side (large flow) to adjust the speed.

#### 6) Procedure before Piping

- The pipeline, piping connector and fixture circuits should be cleaned by thorough flushing.
- Dust and cutting chips in the circuits may lead to oil leakage and malfunction.
- There is no filter provided with Kosmek's product except for a part of valves which prevent contaminants from getting into the circuit.

#### 7) Applying a Sealing Tape

- Wrap with a tape 1 to 2 times following the screw direction.
- Pieces of the sealing tape can lead to oil leakage and malfunction.
- In order to prevent contamination during the piping work, it should be carefully cleaned before working.

#### 8) Air Bleeding of the Hydraulic Circuit

- If the hydraulic circuit has excessive air, the action time may become very long. If air enters the circuit after connecting the hydraulic port or under the condition of no air in the oil tank, please perform the following steps.

- ① Reduce hydraulic pressure to less than 2MPa.
- ② Loosen the cap nut of pipe fitting closest to the clamp by one full turn.
- ③ Wiggle the pipeline to loosen the outlet of pipe fitting.  
Hydraulic fluid filled with the air comes out.

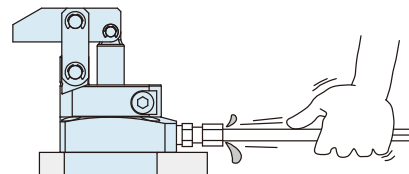

- ④ Tighten the cap nut after bleeding.
- ⑤ It is more effective to bleed air at the highest point inside the circuit or at the end of the circuit. (When using a gasket, Set an air bleeding valve at the highest point inside the circuit.)

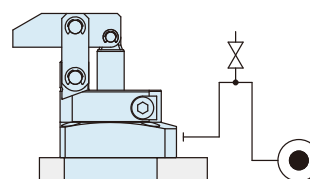

#### 9) Checking Looseness and Retightening

- At the beginning of the product installation, the bolt and nut may be tightened lightly.  
Check the looseness and re-tighten as required.

### ● Hydraulic Fluid List

Maker	ISO Viscosity Grade ISO-VG-32	
	Anti-Wear Hydraulic Oil	Multi-Purpose Hydraulic Oil
Showa Shell Sekiyu	Tellus S2 M 32	Morlina S2 B 32
Idemitsu Kosan	Daphne Hydraulic Fluid 32	Daphne Super Multi Oil 32
JX Nippon Oil & Energy	Super Hyrando 32	Super Mulpus DX 32
Cosmo Oil	Cosmo Hydro AW32	Cosmo New Mighty Super 32
ExxonMobil	Mobil DTE 24	Mobil DTE 24 Light
Matsumura Oil	Hydol AW-32	
Castrol	Hyspin AWS 32	

Note As it may be difficult to purchase the products as shown in the table from overseas, please contact the respective manufacturer.

**Cautions**

● Notes on Hydraulic Cylinder Speed Control Unit



Please pay attention to the cautions below. Design the hydraulic circuit for controlling the action speed of hydraulic cylinder. Improper circuit design may lead to malfunctions and damages. Please review the circuit design in advance.

- Speed Control Circuit for Double Acting Cylinder  
Speed control circuit for double acting cylinder should have meter-out circuits for both the lock and the release sides. Meter-in circuits can be adversely affected by any air in the system.

【Meter-out Circuit】

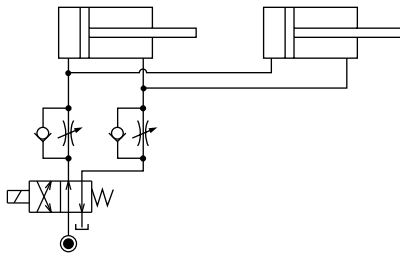

【Meter-in Circuit】

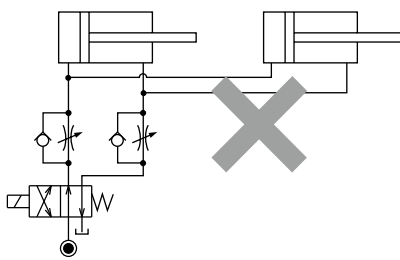

In case of meter-out circuit, hydraulic circuits should be designed with the following points.

- ① Single acting components should not be used in the same flow control circuit as the double acting components. The releasing action of the single acting cylinders may become a malfunction or very slow.

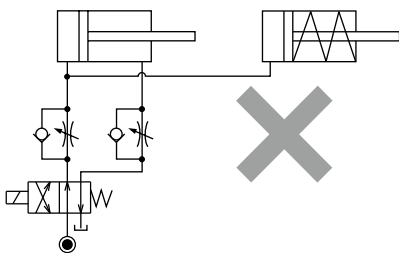

Refer to the following circuit when both the single acting cylinder and double acting cylinder are used together.

- Separate the control circuit.

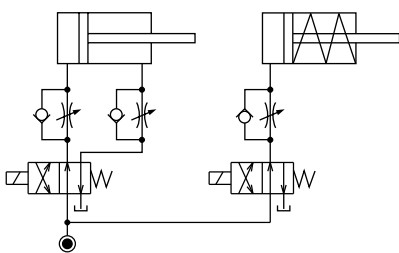

- Reduce the influence of double acting cylinder control unit. However, due to the back pressure in tank line, single acting cylinder may be activated after double acting cylinder works.

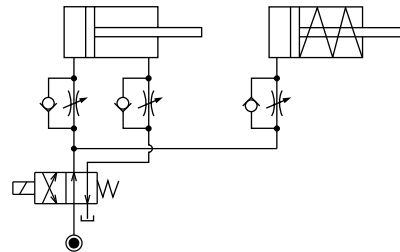

- ② In case of meter-out circuit, circuit pressure may increase during cylinder action depending on a fluid amount. The increase of the circuit pressure can be prevented by reducing the supplied fluid beforehand via the flow control valve. Especially when using a sequence valve or pressure switches for clamping detection, if the back pressure is more than the set pressure then the system will not work as it is designed to.

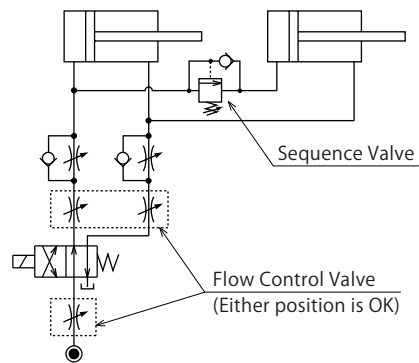



## ● Cautions

### ● Notes on Handling

- 1) It should be handled by qualified personnel.
  - The hydraulic machine and air compressor should be handled and maintained by qualified personnel.
- 2) Do not handle or remove the product unless the safety protocols are ensured.
  - ① The machine and equipment can only be inspected or prepared when it is confirmed that the preventive devices are in place.
  - ② Before the product is removed, make sure that the above-mentioned safety measures are in place. Shut off the pressure and power source, and make sure no pressure exists in the air and hydraulic circuits.
  - ③ After stopping the product, do not remove until the temperature drops.
  - ④ Make sure there is no abnormality in the bolts and respective parts before restarting the machine or equipment.
- 3) Do not touch clamp (cylinder) while clamp (cylinder) is working. Otherwise, your hands may be injured due to clinching.

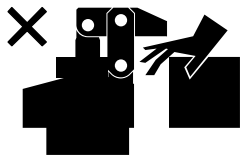

- 4) Do not disassemble or modify.
  - If the equipment is taken apart or modified, the warranty will be voided even within the warranty period.

### ● Maintenance and Inspection

- 1) Removal of the Product and Shut-off of Pressure Source
  - Before the product is removed, make sure that safety measures and preventive devices are in place. Shut off the pressure and power source, and make sure no pressure exists in the air and hydraulic circuits.
  - Make sure there is no abnormality in the bolts and other respective parts before restarting.
- 2) Regularly clean the area around the piston rod and plunger.
  - If it is used when the surface is contaminated with dirt, it may lead to packing seal damage, malfunctioning, fluid and air leaks.

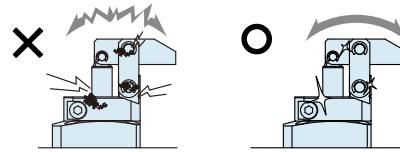

- 3) If disconnecting by couplers, air bleeding should be carried out on a regular basis to avoid air mixed in the circuit.
- 4) Regularly tighten piping, mounting bolts, nuts, snap rings, cylinders and etc., to ensure proper use.
- 5) Make sure the hydraulic fluid has not deteriorated.
- 6) Make sure there is a smooth action and no abnormal noise.
  - Especially when it is restarted after left for a long time, make sure it can be operated correctly.
- 7) The products should be stored in the cool and dark place without direct sunshine or moisture.
- 8) Please contact us for overhaul and repair.

### ● Warranty

- 1) Warranty Period
  - The product warranty period is 18 months from shipment from our factory or 12 months from initial use, whichever is earlier.
- 2) Warranty Scope
  - If the product is damaged or malfunctioned during the warranty period due to a faulty design, materials or workmanship, we will replace or repair the defective part at our expense. Defects or failures caused by the following are not covered.
    - ① If the stipulated maintenance and inspection are not carried out.
    - ② If the product is used while it is not suitable for use based on the operator's judgment, resulting in defect.
    - ③ If it is used or handled in inappropriate way by the operator. (Including damage caused by the misconduct of the third party.)
    - ④ If the defect is caused by reasons other than our responsibility.
    - ⑤ If repair or modifications are carried out by anyone other than Kosmek, or without our approval and confirmation, it will void warranty.
    - ⑥ Other caused by natural disasters or calamities not attributable to our company.
    - ⑦ Parts or replacement expenses due to parts consumption and deterioration. (Such as rubber, plastic, seal material and some electric components.)

Damages excluding from direct result of a product defect shall be excluded from the warranty.



## KOSMEK LTD.

▶ <http://www.kosmek.com/>

HEAD OFFICE 1-5, 2-chome, Murotani, Nishi-ku, Kobe-city, Hyogo, Japan 651-2241  
TEL.+81-78-991-5162 FAX.+81-78-991-8787

United States of America SUBSIDIARY	KOSMEK (USA) LTD. 650 Springer Drive, Lombard, IL 60148 USA TEL. +1-630-620-7650 FAX. +1-630-620-9015
MEXICO REPRESENTATIVE OFFICE	KOSMEK USA Mexico Office Av. Santa Fe #103 int 59 Col. Santa Fe Juriquilla C.P. 76230 Queretaro, Qro Mexico TEL. +52-442-161-2347
EUROPE SUBSIDIARY	KOSMEK EUROPE GmbH Schleppeplatz 2 9020 Klagenfurt am Wörthersee Austria TEL. +43-463-287587 FAX. +43-463-287587-20
INDIA BRANCH OFFICE	KOSMEK LTD. - INDIA F 203, Level-2, First Floor, Prestige Center Point, Cunningham Road, Bangalore -560052 India TEL.+91-9880561695
THAILAND REPRESENTATIVE OFFICE	KOSMEK Thailand Representation Office 67 Soi 58, RAMA 9 Rd., Suanluang, Suanluang, Bangkok 10250, Thailand TEL. +66-2-300-5132 FAX. +66-2-300-5133

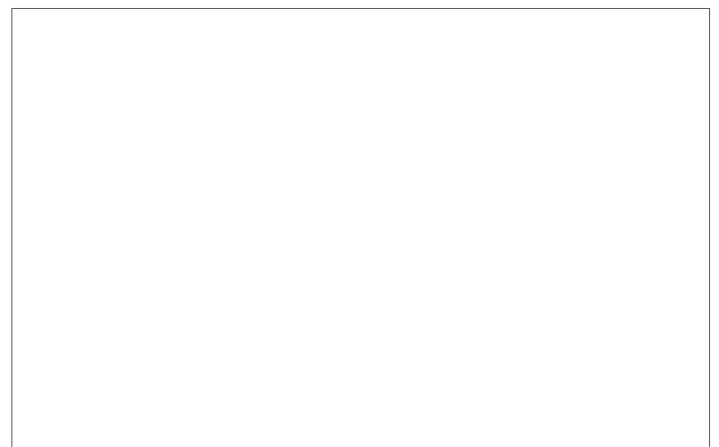

- For Further Information on Unlisted Specifications and Sizes, Please call us.
- Specifications in this Leaflet are Subject to Change without Notice.

